

HIGH TORQUE HYBRID STEPPING MOTOR SPECIFICATIONS

General specifications		Electrical specifications	
Step Angle (°)	1.8	Rated Voltage (V)	2.52
Temperature Rise (°C)	80 Max (rated current, 2 phase on)	Rated Current (A)	2.8
Ambient Temperature (°C)	-20 ~ +50	Resistance Per Phase ($\pm 10\%$ Ω)	0.9 (25°C)
Number of Phase	2	Inductance Per Phase ($\pm 20\%$ mH)	2.5
Insulation Resistance (M Ω)	100 Min (500VDC)	Holding Torque (N.cm)	126
Insulation Class	Class B		
Max. radial force (N)	28 (20mm from the flange)		
Max. axial force (N)	10		

● Wiring Diagram :

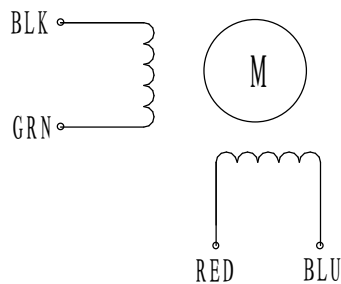

● Pull out torque curve :

VOLTAGE: 30VAC, CONSTANT CURRENT: 2.8A, HALF STEP

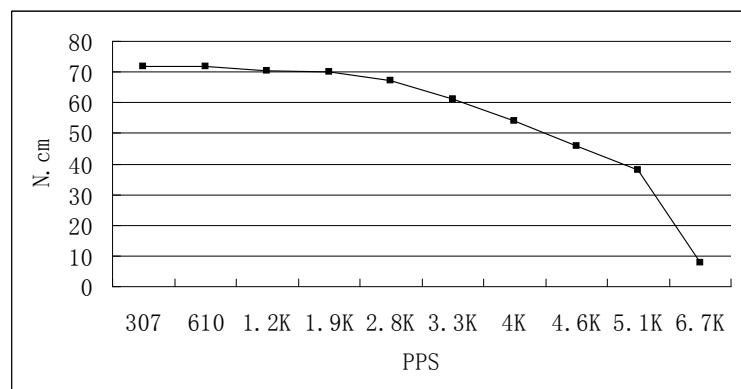

● Dimensions:

(unit=mm)

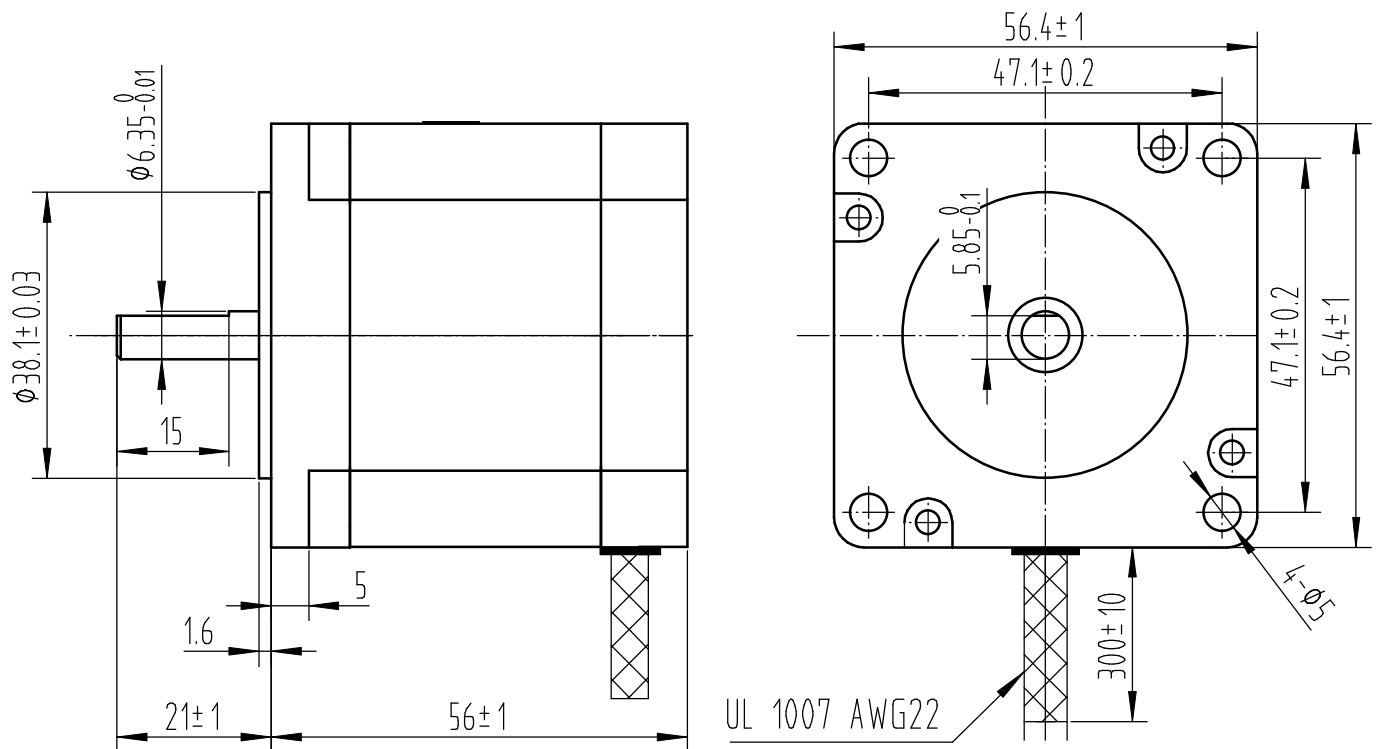

					SY57STH56-2804A	TECHNICAL CONDITIONS
REV	REVISIONS	DESCRIPTION	BY	DATE	CHANGZHOU SONGYANG MACHINERY & ELECTRONICS NEW TECHNIC INSTITUTE	080056019
DRAW	2013/06/12					
CHECK						
APPROVE						

This document was created with Win2PDF available at <http://www.win2pdf.com>.
The unregistered version of Win2PDF is for evaluation or non-commercial use only.
This page will not be added after purchasing Win2PDF.